

# IR Receiver Modules for Remote Control Systems

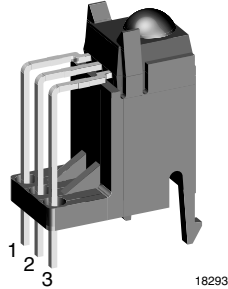

18293

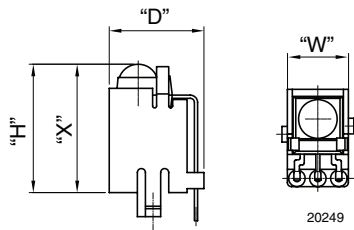

20249

**FEATURES**

- Compliant to RoHS directive 2002/95/EC and in accordance to WEEE 2002/96/EC

**AVAILABLE FOR:**

- TSOP34...
- TSOP4....
- TSOP32...
- TSOP2....

**RoHS**  
COMPLIANT

NAME	LENS AXIS (X)	VIEW	TYPE	HEIGHT (H)	WIDTH (W)	DEPTH (D)
ZC1	16	Top	Holder	16	7.4	14

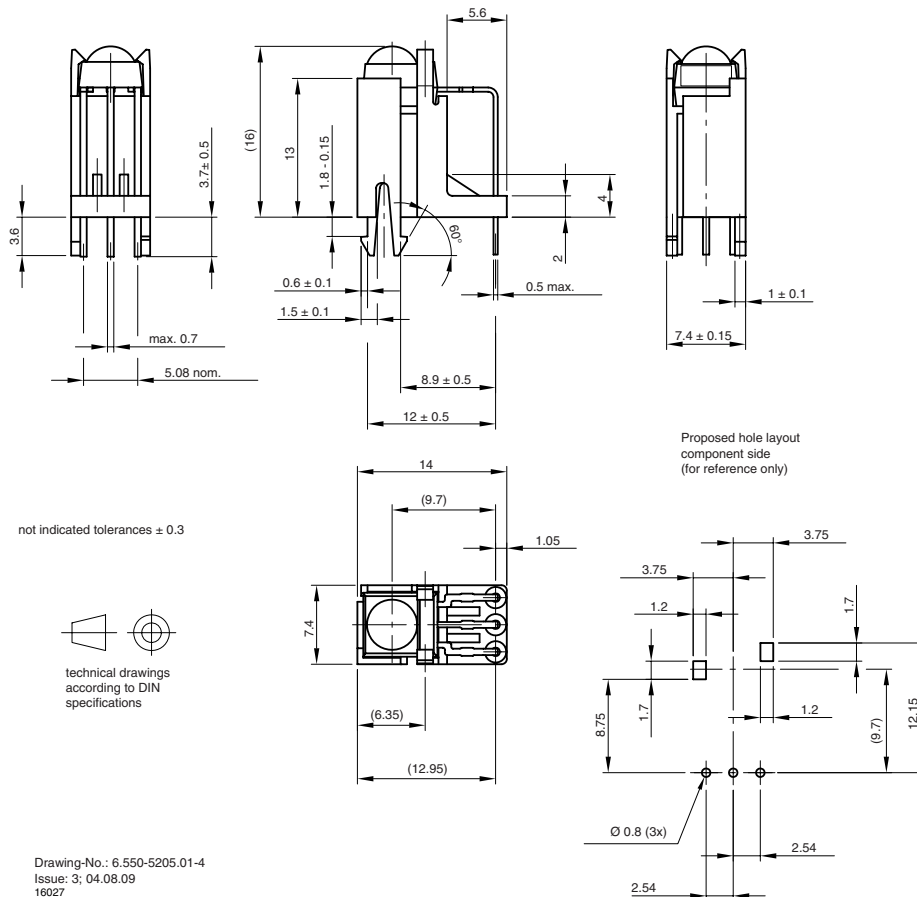
**MECHANICAL DIMENSIONS** in millimeters

**PACKAGING DIMENSIONS** in millimeters

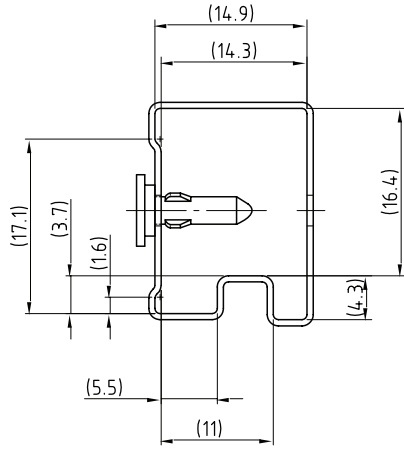

Wanddicke/wall thickness: 0.6  
Bohrungen durchgehend  
holes on both sides

Druck / Printing for tubes  
1400-5548.0-3 Version 1

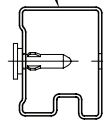

1:1

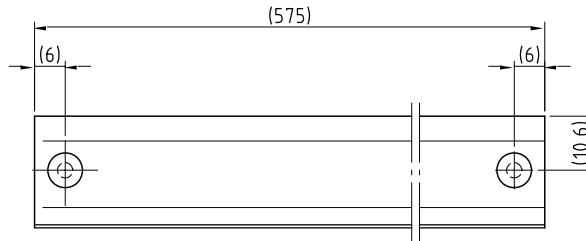

Drawing-No.: 9.700-5228.0-4  
Rev. 6; Date: 20.11.03

20266-1

**ORDERING INFORMATION**

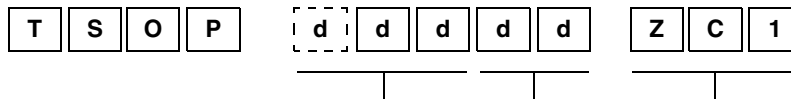

2 or 3 digit product series    2 digit frequency    Holder type

**Note**

d = "digit", please consult the list of available series on the previous page to create a valid part number.

**Example: TSOP14838ZC1**

**PACKING QUANTITY**

- 75 pieces per tube
- 27 tubes per carton